



## INSTRUCTION MANUAL

# TAIJI HOTCABI Towel Warmer

**Model: HC-38, HC-38UV**

### Table of Contents:

|   |      |
|---|------|
| 1. Safety Precautions.....                | 2~5  |
| 2. Purpose of Use.....                    | 6    |
| 3. Operational Mechanism.....             | 6    |
| 4. Parts Identification.....              | 6    |
| 5. Prior to use & Setting.....            | 7    |
| 6. Operation (Pre-use Instructions).....  | 7~8  |
| 7. Operation (Post-use Instructions)..... | 8~9  |
| 8. Product specifications.....            | 9~10 |
| 9. Servicing.....                         | 10   |

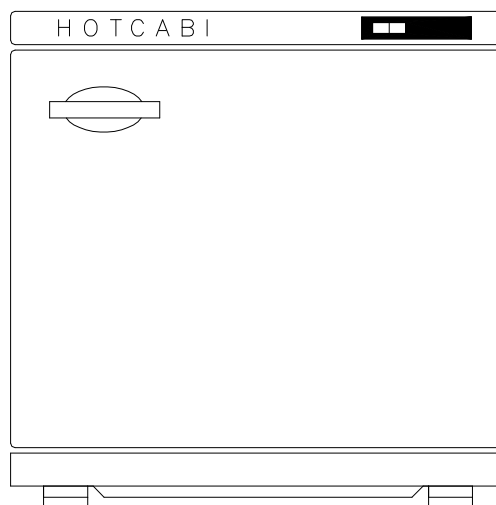

- To use the product correctly and safely, carefully read and fully understand the contents of this instruction manual prior to use.
- This booklet covers mainly safety precautions, parts identification, instructions for use, servicing, and product specifications.
- Failure to observe the precautions given in this booklet may result in death and physical injuries. Do not to use the product in a manner which does not conform to the instructions given herein.
- Caution: Before attempting to connect or operate this product, please read the label on the back



The serial number of this product may be found on the back of the product. You should note the serial number of this product in the space provided and retain this booklet as a permanent record of your purchase for after-sales servicing.



Model No. : \_\_\_\_\_

Serial No. : \_\_\_\_\_



# SAFETY PRECAUTIONS

- Keep these “Safety Precautions” handy for future reference after read.
- Precautionary measure referred to herein are matters which should be abided by for safe use and to prevent harm and/or damage being inflicted on yourself or others. Furthermore, the particulars of the precautionary measures have been classified into “Warning” and “Caution” to express the degree or extent of conceivable harm and damage which can be assumed to occur from mishandling. They are both of importance as far as safety is concerned and should be strictly abided by.
- Specifications and the product are subject to change without any obligation on the part of the manufacture.











|   |  |
|---|--|
|  <div style="border: 1px solid black; padding: 5px; display: inline-block; text-align: center;"> <p><b>CAUTION</b></p> <p>RISK OF ELECTRIC SHOCK</p> <p>DO NOT OPEN</p> </div>  | <p><b>CAUTION:</b></p> <p>TO REDUCE THE RISK OF ELECTRIC SHOCK, DO NOT REMOVE COVER (OR BACK).</p> <p>NO USER SERVICEABLE PARTS INSIDE.</p> <p>REFER SERVICING TO QUALIFIED SERVICE PERSONNEL.</p> |
|---|--|



|   |   |
|---|---|
|  <p><b>WARNING</b></p> | What is assumed to possibly result in death or serious injury               |
|  <p><b>CAUTION</b></p> | What is assumed to possibly result only in bodily injury or physical damage |









■ What precautionary measures should be abided by area expressed by certain marks and explained as follows:









|   |   |
|---|---|
|  | <p>△mark denotes that “Warning and caution is urged”.</p> <p>(The one on the left indicates beware of electrical shock.)</p>                    |
|  | <p>⊘ mark with a diagonal line means “Forbidden.”.</p> <p>(The one on the left indicates beware of electrical shock.)</p>                       |
|  | <p>●mark indicates “Instructions” which should be followed by all means.</p> <p>(The one on the left indicates grounding is a requirement.)</p> |

## WARNING

|  |  |
|--|--|
| <p>Do not disassemble:</p>              | <p>Do not disassemble, repair nor modify the product by anyone other than a repair technician. It may cause unexpected flashing or electric shock and abnormal performance.</p>  |
| <p>Connect ground terminal:</p>         | <p>The product is equipped with a power plug with ground terminal. Connect ground terminal firmly. No ground connection or improper connection may cause an electric shock. Do not ground to gas piping or water piping.</p>   |
| <p>Attention required for setting:</p>  | <p>To be set upon a stable and flat location and not to be removed while plug is connected to power source. Could result in abnormal performance.</p>  |
| <p>No water:</p>                        | <p>Do not immerse in or douse with water. Such could result in electric shock or short-circuit.</p>  |
| <p>Check and clean:</p>                 | <p>Periodically confirm that the plug contacts are kept clean and they are firmly inserted in the power outlet. Dust accumulation or imperfect contact could be the cause of an electric shock or fire.</p>  |
| <p>Do not damage power cord:</p>       | <p>Handle the power cord with care. In case the power cord is processed, pulled, bundled, or a heavy item is placed upon or squeezes it, the cord is apt to be damaged and could cause an electric shock or fire.<br/>The power cord should not come into contact with a heat source.</p>                        |
| <p>Removing plug:</p>                 | <p>In the event of abnormal odor, sound, or emission of smoke, or in case water or foreign substance should enter the cabinet, switch off the unit immediately and remove the plug from the electric outlet. Such could possibly lead to an electric shock and outbreak of fire.</p>                             |
| <p>Do not use outdoors:</p>           | <p>Do not use the product outdoors. Rainfall, snow or fog may cause an electric leakage and/or electric shock.</p>   |
| <p>Do not discard:</p>                | <p>Discarding of "HOTCABI" should be requested of specialized contractor, public agency or the distributor from where the product was purchased. Discarding it at random could result in third party remodeling, using it for purposes other than as designed, which could result in an unexpected accident.</p> |
| <p>Do not put heavy items:</p>        | <p>Do not place heavy items or one's weight on door edge with its door open. It may cause door drop and any injuries by the toppling.</p>  |
| <p>No humidity:</p>                   | <p>Do not place the product at humid place. It may cause an electric shock due to bad electrical insulation and leakage.</p>   |

|  |  |
|--|--|
| Use independent outlet:           | Ensure power source is from dedicated outlet of at least 15A (110–120V), or at least 8A (220–240V). Using branch sockets could be the cause of abnormal heat, fire, etc. |
| Do not bend power plug contacts:  | Do not bend plug contacts to prevent the plug from dropping out of the electric outlet. Imperfect contact could be the cause of fire.                                    |
| Hold plug to remove:              | Hold the plug and not the cord when removing the plug from the electric outlet. Not doing so could result in an electric shock or ignition.                              |

|  <b>CAUTION</b>   |  |
|--|--|
| Do not touch with wet-hand:   | Do not touch or operate electric parts such as the plug, switch and etc. It may cause an electric shock.   |
| Do not drop:    | Do not drop the product or give strong pressure on it. It may cause mechanical/electrical problems or fire.  |
| Discard of packing plastic bag immediately:    | Discard immediately the plastic bag which the product was packed inside. Keep it out of children's reach to prevent incidents of suffocation.  |
| Do not place heavy items:   | Do not place heavy items or water containers on top of "HOTCABI". Such may cause damage, injury, short-circuit, electric shock, corrosion, failure, by drop or toppling.   |
| Use individually wrapped towels:<br><br>Use heat resisting polyethylene wrapper:   | Use pre-moistened towels which come in heat resisting polyethylene wrapper. Towels sometimes get dry or discolor if not polyethylene pouched. When using towel from home (as opposed to those provided by special suppliers), wring them out rather tightly (to some 2.5 times the dry weight), place them in a polyethylene wrapper and seal the wrapped towels for use.<br><br>Use heat resisting at least at least 248° F (120°C) polyethylene wrapper. When polyethylene or vinyl wrappers with a low heat resisting property are used, they may at times melt making towels useless or cause discoloration. |
| Use basket:   | Always place towels on the basket and then store in the cabinet. If not, wrapper could melt and make towels useless or cause discoloration.  |
| Do not storage too many towels:   | Do not storage too many towels to prevent touching to inner box surface where it may excess over 212° F (100°C). Polyethylene bag may be melted and it cause of changing towel color.  |

|  |   |
|--|---|
| <p>Do not storage longer:</p>                                 | <p>Do not leave the same towel within the inner box for more than one day. It could be the cause of discoloration and bad odor.</p>   |
| <p>High temperature:</p>                                      | <p>To avoid burns, do not touch the surface of the inner cabinet when the unit is heated. Use caution when taking out or placing towels in the inner box when it is switched on.</p>  |
| <p>Remove drain water:</p>                                    | <p>Empty drain tray frequently. Accumulation of water could lead to overflowing and cause bad odor.</p>   |
| <p>Eliminating moisture:</p>                                  | <p>Wipe off moisture within the inner box as well as the body after use and remove any foreign substances. If not, it will cause the discoloration and bad odor of towels. It will lead to malfunctioning when used thereafter.</p>   |
| <p>Removing plug:</p>   | <p>Remove the plug from the electric outlet as soon as thunder is heard. In the event of a nearby lightening strike, abnormal current/abnormal voltage could infiltrate through the power source line, etc. and possibly damage the product.</p>  |
| <p>When not in use</p>                                        | <p>Switch off and remove the plug from electric outlet when not in use. If you do not, it could be the cause of an electric shock, electric leakage, fire, etc.</p>   |
| <p>Attention required for using:</p>                        | <p>This appliance is not intended for use by persons with reduced physical, sensory or mental capabilities, or lack of experience and knowledge, unless they have been given supervision or instruction concerning use of the appliance by a person responsible for their safety. Do not have children alone use “HOTCABI” and take care to place it out of reach of infants. They could suffer from an electric shock or other injuries.</p>   |
| <p>Do not attach oil or chemicals on the plastic part:</p>  | <p>Do not keep in “HOTCABI” towels or other materials which contain or soaked with oils or chemicals. Also, do not touch plastic parts of “HOTCABI” with hands adhered oil or cream. Some oil or chemicals used in therapies may damage or crack the inside of “HOTCABI” over time if not cleaned off properly. The area in and around the door is especially vulnerable. Wipe all plastic parts daily with a soft cloth soaked in neutral detergent solution diluted with hot water. Then, dry off with a soft cloth if you use such oil or chemicals.</p> |

# PURPOSE OF USE

This product is an electric towel warmer which is fabricated to keep pre-moistened towels at warm condition for indoor use. Should you wish to use it for any other purpose, please contact Taiji & Co., Ltd.

# OPERATIONAL MECHANISM

This product is equipped with a heating element to keep towels within the cabinet warm. By a thermostat, the temperature within the cabinet will be maintained between 70°C (158° F) and 80°C (176° F) when room temperature is 20°C (68° F).

(The above indicates the temperature at the center of the inner cabinet.)

HC-38UV has GTL-2 2W UV lamps sterilizes inside the cabinet wall surface.

# PARTS IDENTIFICATION

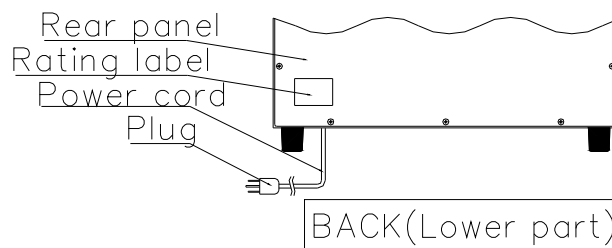
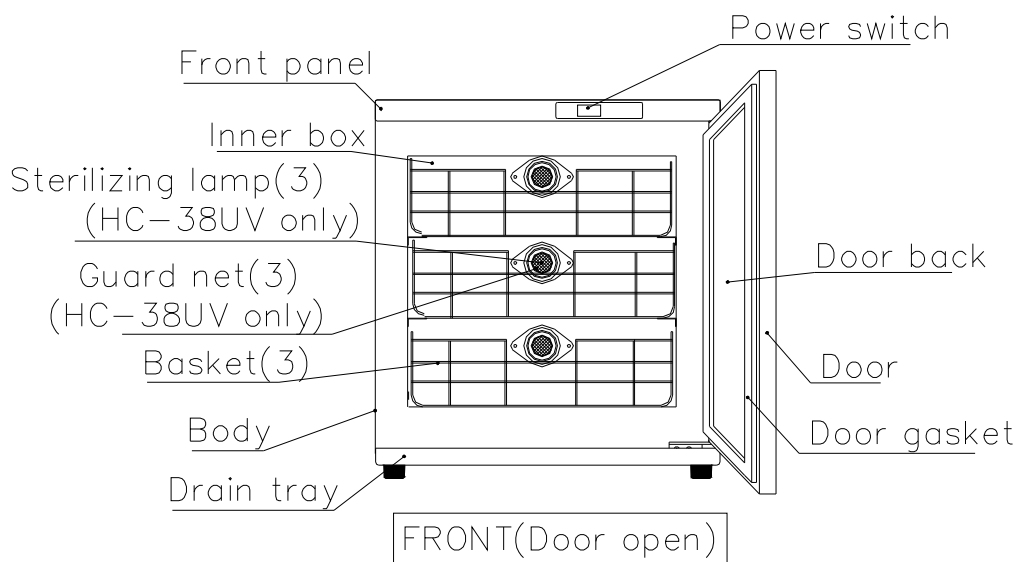

# PRIOR TO USE & SETTING

1. Remove “HOTCABI” from packing carton and make sure that a instruction manual and accessories are included.
2. Set “HOTCABI” as follows:
  - ✧ At a place where it is flat and stable.
  - ✧ At a place where it is not affected by heat. Avoid places where there is direct sunlight, and do not place near stoves, microwave oven, etc. Keep “HOTCABI” away from such units by at least 50 cm (19.68 inch).
  - ✧ Keep “HOTCABI” away from moist places or where it is susceptible to being splashed with water.
  - ✧ Leave a space between “HOTCABI” and whatever may be placed next to it and make sure there is space all around the unit to allow ventilation.
3. Grounding  
Ensure correct grounding is secured to protect against electric shock. Consult with your dealer for details.
4. Affixing drain tray  
Hold both sides of a drain tray horizontally and push in until firmly inserted. When water accumulates in the tray, remove and empty carefully. Reinsert the drain tray after being emptied.
5. Use an independent power outlet. Be sure to plug in the power plug to a power outlet of 110–120V AC 15A minimum or 220–240V AC 8A minimum, to which nothing else is connected.

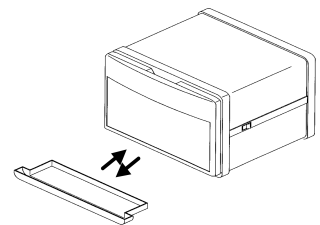

## OPERATION

**SAFETY DEVICE: WHEN THE TEMPERATURE OF THE PRODUCT INSIDE EXCEEDS THE UPPER LIMITS ABNORMALLY BY ANY MEANS, THE THERMAL FUSE BLOWS OUT THE ELECTRIC CIRCUIT. WHEN IT WORKS, TURN OFF AND TAKE OFF THE POWER PLUG FROM ELECTRIC OUTLET AND CONSULT TO TAJI PRODUCTS DEALER OR OUR SERVICE FACILITIES.**

### Pre-use Instructions

1. Be sure that power switch is “OFF” position.
2. In case the inner box is moist or there are foreign substances on its surface, wipe clean with a dry towel, etc.  
\*Any remaining moisture, etc. could cause failure or malfunction.
3. Connect the plug to the electric outlet. Be sure that power plug must be inserted correctly in the position.

4. Open the door and take off the basket.

5. Place wet rolled towels on the basket.

\*In the event the amount of towels put into the box is low, place them on the basket as flat and as far apart as possible.

\*The interior of the cabinet becomes heated from the wall surface. Place towels inside the cabinet so that they do not come into contact with such surfaces.

\*When warm towels are needed in a hurry, use towels that have been rolled after having been immersed in warm water.

\*Put towels in heat resisting polyethylene wrap. If used without such wrapper, towels are apt to drying up quickly or becoming discolored.

6. Close the door tightly and switch on. Power pilot lamp is lit and warming commences.

\*Empty drain tray frequently.

\*UV lamp is lit up when switch on the power (HC-38UV only). UV lamp dose not work while the door is opened to protect human being's eyes.

\*To check UV lamp performance, put magnet to front panel upper left corner where lead switch is installed underneath of the front panel. Do not stare UV light for a long while.

\*The life of UV lamp is 3,000 hours for continuous use under the normal condition.

Replace UV lamp every 1-2 years.

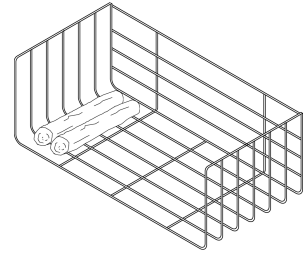

**WARNINGS:**

**TOWELS, STEAM, BASKET AND INSIDE SURFACE ARE HOT AND DANGEROUS. USE EXTREME CAUTION WHEN PULACING OR TAIKING OUT HOT TOWELS OR BASKET FROM THE PRODUCT. ALWAYS USE PROTECTIVE GLOVES WHEN HANDLING HOT TOWELS AND BASKET. CARELESS OR INATTENTIVE HANDLING COULD RESULT IN BURNS OR OTHER SERIOUS PHYSICAL INJURIES.**

**Post-use Instructions**

1. Switch off the power and remove the plug from electric outlet. Power switch lamp will go off while power is not supplied.

2. Take out remaining towels and wipe inner box clean to remove residual moisture after the product is cool down properly.

3. Empty water accumulated in the drain tray. Wash clean when considerable stained.

4. Stains on the main body should be wiped clean with a dry cloth or a tightly wrung wet cloth.

\*Use a neutral detergent when stains are severe. Do not use cleansers containing abrasives or solvents such as paint solvents.

5. Leave the door of the cabinet open for while for moisture to dry as a means to prevent odors.



**WARNINGS:**

PLEASE DO NOT KEEP IN YOUR "HOTCABI" TOWELS OR OTHER MATERIALS WHICH CONTAIN OR SOAKED WITH OILS OR CHEMICALS. SOME OILS OR CHEMICALS USED IN THERAPIES MAY DAMAGE OR CRACK THE INSIDE OF YOUR "HOTCABI" OVER TIME IF NOT CLEANED OFF PROPERLY. IF YOU ARE USING SUCH CHEMICALS MAKE IT A RULE TO WIPE ALL PLASTIC PARTS DAILY WITH A SOFT CLOTH SOAKED IN A NEUTRAL DETERGENT SOLUTION DILUTED WITH HOT WATER AND THEN DRY OFF WITH A SOFT CLOTH. PLEASE NOTE THAT THE AREA IN AND AROUND THE DOOR IS ESPECIALLY VULNERABLE.

## PRODUCT SPECIFICATIONS

Circuit diagram:

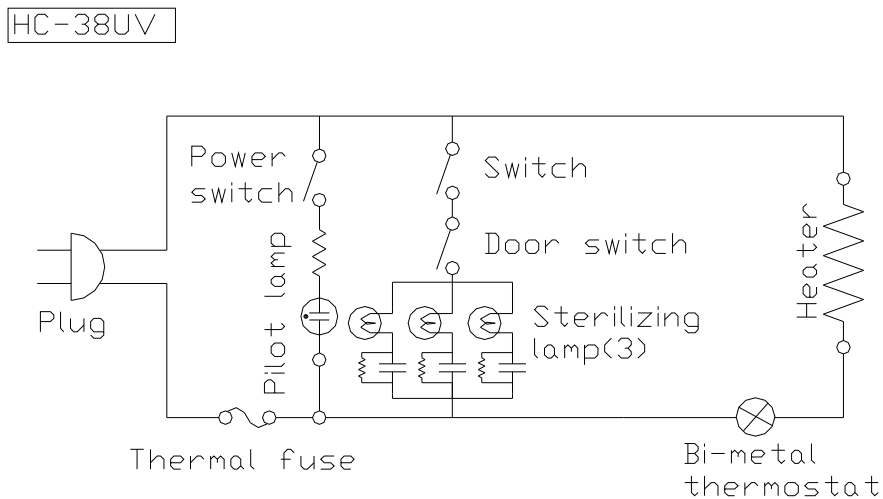
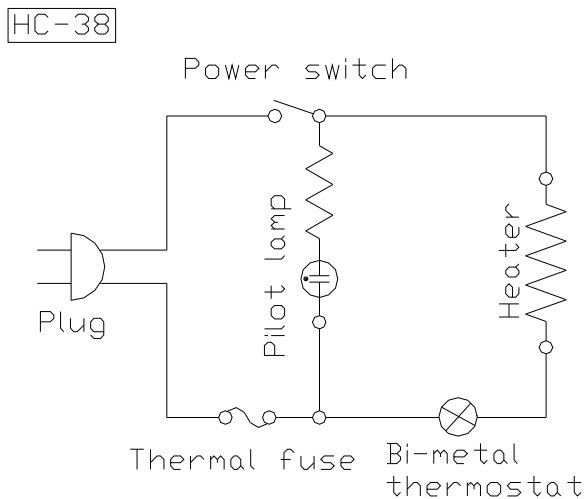

Specifications:

|                                      |   |
|--------------------------------------|---|
| Model No.:                           | HC-38/HC-38UV   |
| Rated power supply:                  | Single phase 110-120V , 220-240V AC 50/60Hz.              |
| Consumption power:                   | 400W  |
| Temp. control:                       | Bimetal thermostat  |
| Inner box temp. range:               | 70-80°C (158-176° F)<br>at room temp. 20°C (68° F)        |
| Safety device:                       | Thermal fuse  |
| Outer dimensions:                    | 450(W)x410(D)x450(H)mm<br>(17.716 x 16.142 x 17.716 in)   |
| Inner dimensions:                    | 360(W)x316.5(D)x345(H)mm<br>(14.173 x 12.461 x 13.583 in) |
| Inner box capacity:                  | 38 liters   |
| Weight:                              | 12.0 kg<br>(26.455 lb)                                    |
| Sterilizing UV light (HC-38UV only): | GTL-2 2W  |
| Accessories:                         | Basket x 3, Drain tray x 1                                |

\*Subject to change without notice.

## SERVICING

For after-sales service, call the store where you have purchased your towel warmer, or nearest TAJI sales representative or TAJI & CO., LTD. in JAPAN.

### TAJI & CO., LTD.

8-2 Okawa-cho, Kawasaki-ku, Kawasaki-shi, Kanagawa-ken, 210-0858, Japan

Phone: +81-44-329-6338

Fax: +81-44-329-5860

E-mail: [overseas@taiji.co.jp](mailto:overseas@taiji.co.jp)

URL: <http://www.taiji.co.jp/e>

revised on 5/19/2011